



**Metrologic**  
We really work for you.™

MS2122  
compact scanner

## MS2122 Series **StratosE™**

**StratosE™** is the smallest 6-sided bioptic scanner in the market designed for high throughput POS applications requiring enclosures around the vertical tower and a cash box in front of the scanner.

StratosE is the most compact 6-sided scanner in the market perfectly suited for space constrained POS applications demanding high throughput 6-sided scanning. Its compact form factor, including a 399 mm (15.7") length and 100 mm (4") below counter depth, is designed to allow easy integration into most of today's seated and standing checkout environments.

StratosE is a 6-sided, 360° in counter scanner incorporating Stratos advanced scanning architecture and Stratos**SPHERE™** decoding software providing high throughput scanning with minimal need for product orientation.

StratosE comes equipped with Stratos**SCOPE™**, a visual diagnostic indicator providing immediate feedback on scanner condition and a Checkpoint compatible EAS activation antenna for simultaneous EAS security tag deactivation and bar code scanning. Stratos**SCHOOL™** operator training software allows operators to improve scanning technique allowing for greater productivity and safer scanning methods.

Additionally, StratosE features a powered RS232 auxiliary port for integration of a hand-held bar code scanner, flash ROM firmware upgrade capability, MetroSet®2 PC based configuring and sapphire or diamonex based horizontal glass.

[www.metrologic.com/MS2122](http://www.metrologic.com/MS2122)



### FEATURES

- 6-sided, 360° scanning
- Flash ROM - firmware upgrades via PC
- Stratos**SYNC™** vertical and horizontal scanning zones
- Stratos**SCHOOL™** operator training software
- Stratos**SWAP™** field replaceable optical modules

### BENEFITS

- Improves productivity and operator ergonomics by reducing product orientation
- Upgrades can be performed at the checkout lane thus lowering the cost of service
- Maintains productivity and uptime via independent scanning zones
- Increases productivity and promotes safer scanning techniques
- Minimizes down time and lowers the cost of service

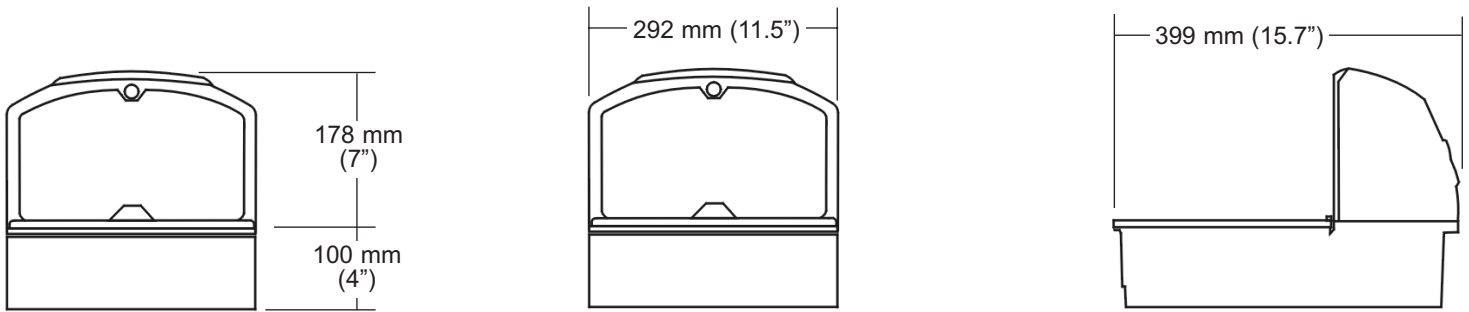

**OPERATIONAL**

Light Source	Visible Laser Diode 650 nm ± 10 nm
Laser Power - (horz/vert)	1.1 mW / 1.5 mW
Motor Speed - (horz/vert)	4800 / 6000 RPM
Sides Read	6
Decode Capability	All standard 1-D bar codes, RSS-14, RSS-Expanded, RSS-14 Limited
System Interfaces	RS-232, Aux. RS-232, IBM468x/469x, USB, OCIA
Number Characters Read	Up to 80 data characters
Speaker Operation	7 tones or no beep; 3 volume settings
Indicators (LED)	Blue = laser on, ready to scan; White = good read, decoding

**MECHANICAL**

Length	399 mm (15.7")
Width	292 mm (11.5")
Depth (below counter)	100 mm (4")
Height (above counter)	178 mm (7")
Weight	6.8 kg (15 lbs)

**ELECTRICAL**

Input Voltage	5.2 V @ 1.5 Amps / 12 V @ 1.5 Amp
Power	13.5 W (when scanning); 5 W (standby)
Operating Current	900 mA (5V) / 700 mA (12V)
DC Transformers	Class 1; 5 VDC @ 1.5 A; 12 VDC @ 1.5 A
Laser Class	CDRH & IEC: CLASS 1 according to IEC 60825-1:1993 + A1:1997 + A2:2001
EMC	FCC, ICES-003 & EN55022 Class A

**ENVIRONMENTAL**



Operating Temperature	0°C to 40°C (32°F to 104°F)
Storage Temperature	-40°C to 60°C (-40°F to 140°F)
Humidity	5% to 95% relative humidity, non-condensing
IP Rating	IP 55
Light Levels	4842 Lux (450 footcandles)
Contaminants	Sealed to resist airborne particulate contaminants
Ventilation	None required

**SCAN PERFORMANCE**







Depth of Scan Field - (horz)	0 mm - 152 mm (0" - 6") for 0.33 mm (13 mil) bar code
Depth of Scan Field - (vert)	0 mm - 216 mm (0" - 8.5") for 0.33 mm (13 mil) bar code
Scan Speed	6000 scan lines per second
No. of scan lines - (horz/vert)	66 (38 / 28)
Scan Zone	360°
Minimum Bar Width	0.152 mm (6 mil)
Print Contrast	35% minimum reflectance difference
Roll, Pitch, Yaw	360°, 60°, 60°



Product Colors Available

Dark Grey  Black 

MS2122 is available in a variety of other colors with minimum quantity purchase

Revision: D + above

Specifications subject to change without notice. Printed U.S.A., Copyright October 2007 Metrologic, All rights reserved.



Metrologic Instruments, Inc. | **Worldwide Headquarters**  
 90 Coles Road | Blackwood, NJ 08012-4683 | www.metrologic.com  
 Telephone 856-228-8100 | Fax 856-228-6673 | info@metrologic.com

**ISO 9001:2000**

<b>Asian Headquarters</b> Tel. 65.6842.7155 info@sg.metrologic.com	<b>European Headquarters</b> Tel. 49.89.89019.0 info@eu.metrologic.com	<b>The Americas Headquarters</b> Tel. 1.800.ID.METRO info@us.metrologic.com
--------------------------------------------------------------------------	------------------------------------------------------------------------------	-----------------------------------------------------------------------------------



DS2122